

# STR Periscope **STR240**

*20 % Higher Capacity  
Very Compact Integration  
Suitable for Crystallization*

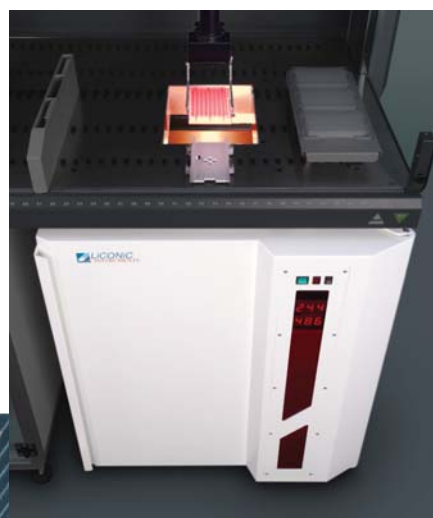

STR240 Series

## STR240

The STR is the most versatile incubator in the market. Fits underneath any work-station or liquid handling system. Reduces your bottlenecks by 50%, when using multiple plate transfer nests. You optimise your budget because you do not have to buy extended or articulating robotic arms.

240 Plate capacities in such a foot print is cutting edge technology.

The periscope delivery shovel presents the plate to the top of the work space. With work space at a premium, the STR will save valuable space for other components above your system and gives you a more aesthetically pleasing compact appearance.

All this without sacrificing price.

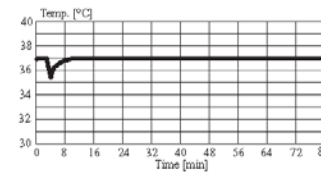

Access through the small robotic gate

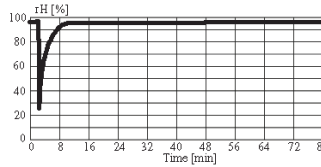
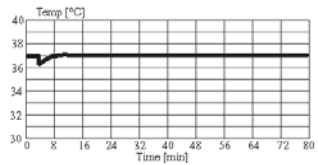

Access through full-sized user door

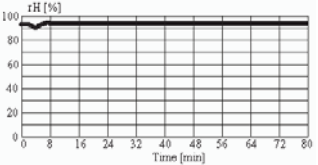

### Climate Options

Type	Temperature	Humidity	Description	Order Nr.
STR240-IC	33..50°C (70°C)	max. 95%	Incubator	9143 00 91
STR240-HC <sup>1)</sup>	04..25°C	max. 90%	Humid Cooler	9143 00 92
STR240-DC2 <sup>1) 3)</sup>	04..25°C	04..50%	Dry Storage	9122 05 32
STR240-HR <sup>1)</sup>	04..50°C (70°C)	90..95%	Humid Wide Range	9143 00 93
STR240-DR <sup>1) 3)</sup>	04..50°C	02..80%	Dry Wide Range	9122 05 30
STR240-AR <sup>2)</sup>	04..50°C	20..90%	Humidity Controlled	9143 01 96
STR240-IC2 <sup>4)</sup>	33..50°C (70°C)	20..95%	Humidity Heated	9143 01 98
STR240-DF <sup>1)</sup>	-20..20°C	02..45%	Deep Freezer	9122 05 29
STR240-NC	-	-	No Climate	9143 02 04

<sup>1)</sup> Humidity depends on temperature setting / <sup>2)</sup> Humidity Adjustable / <sup>3)</sup> Adjustable dehumidification / <sup>4)</sup> Adjustable humidification

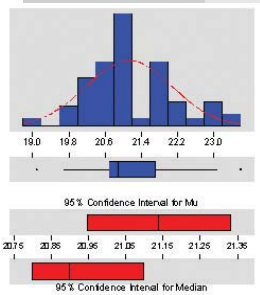

The average Access time is 21.1 seconds

### Options

	Order Nr.	Gassing Option	Order Nr.
High temperature 70°C capability	9122 06 02	Fast CO2 Gassing Option	9118 11 12
Bar Code Reader Option	9118 11 03	Fast N2 Gassing Option	9118 11 13
Plate Presence Sensor	9121 00 62	Fast O2 Gassing Option	9118 11 14
Disposal Tips upgrade kit up to 100mm height	9118 12 23	Additional CO2 Gassing Option	9118 11 07
Fast access for time critical applications	9111 10 00	Additional N2 Gassing Option	9118 11 11
N-Way Decontamination	9122 05 28	Additional O2 Gassing Option	9118 11 08
Liconel self decontaminating incubator chamber	9143 01 97		
Linear Shaker, Amplitude 1-100mm, 12-300 rpm	9143 02 00		
UCI Universal Communication Interface	9118 11 17		
Steam Injection	9118 11 16		

Like all members of the StoreX Star family the STR240 can be equipped with a large number of further options and a wide selection of useful accessories. For details please visit [www.liconic.com](http://www.liconic.com).

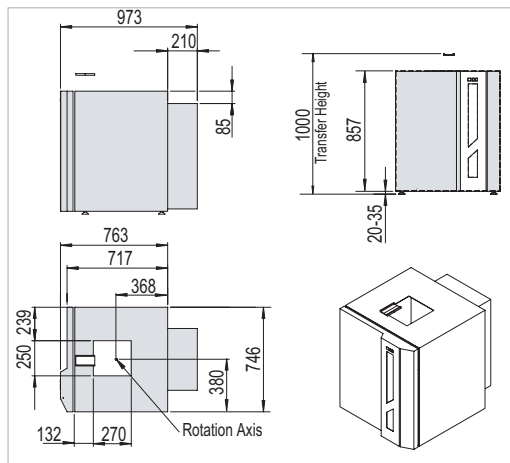

### Capacity

Plate Type	Plate Height	Plate capacity of unit	
NTP (Nanotiter Plates)	5 mm	462	
	11 mm	308	
1536	12 mm	297	
	MTP (Microtiter Plates)	17 mm	240
	22 mm	187	
	23 mm	187	
	24 mm	187	
DWP (Deep Well Plates)	27 mm	165	
	44 mm	110	
	53 mm	88	
DiTi200	66 mm	77	
DiTi1000	104 mm	44	