

1 2 3 4 5 6

A

A

B

B

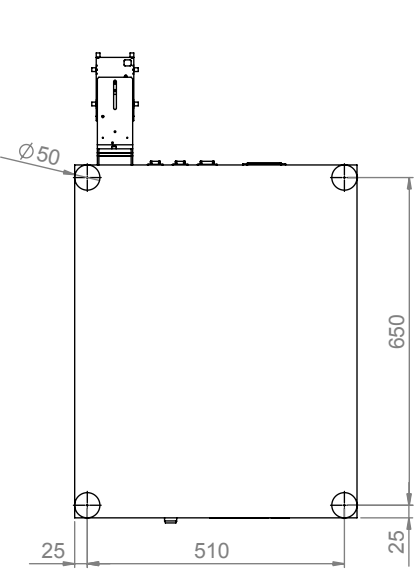
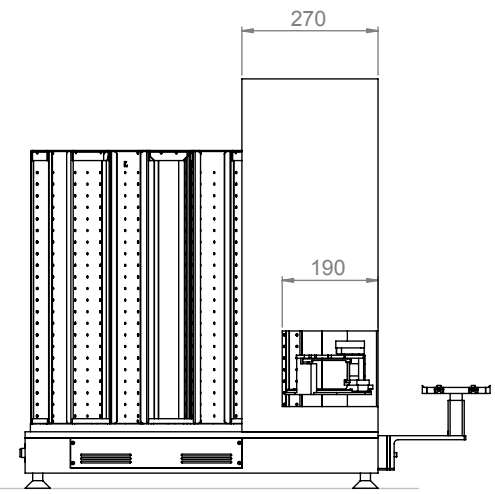
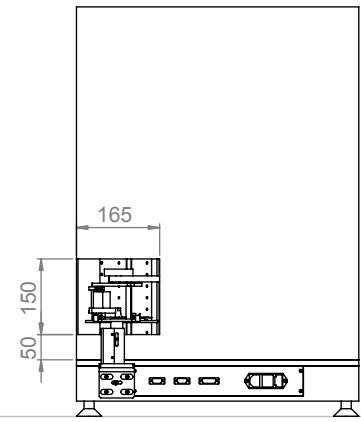
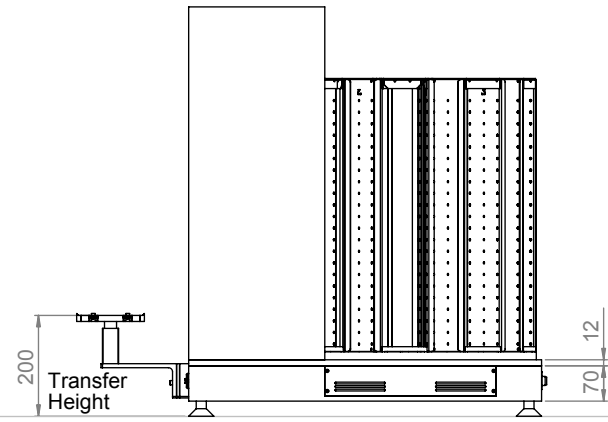
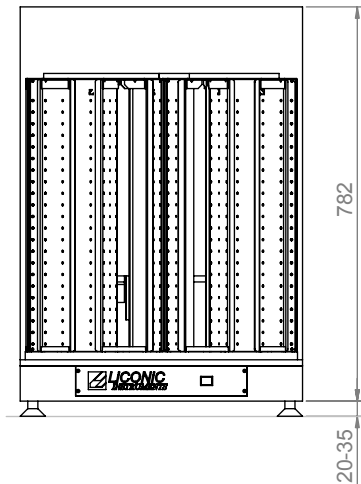

Bottom

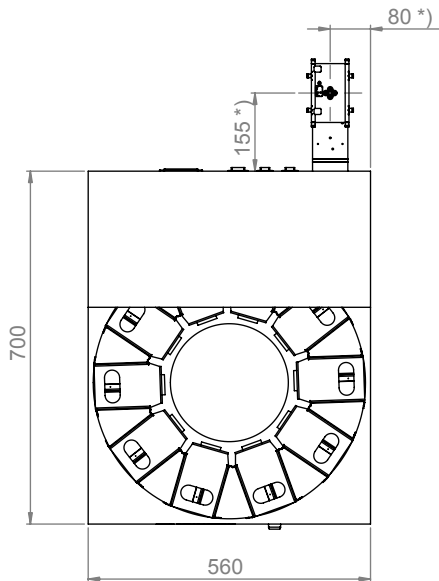

Top

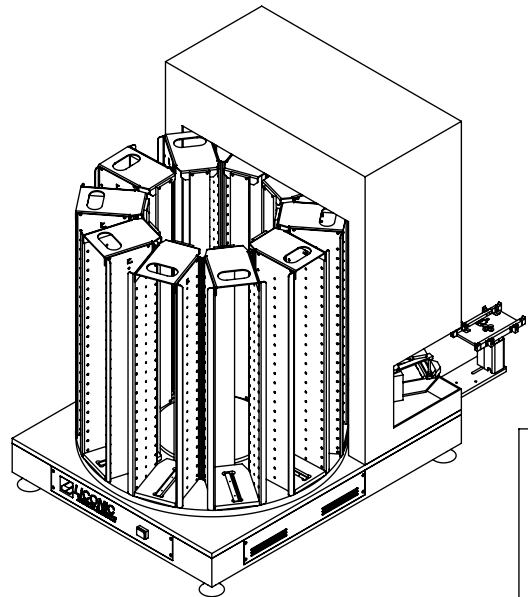

Liconic AG
LPX220 Housing
(Case C)

*) value may vary depending on handling position within chamber

1